

- 5 Connect / Reconnect track to power and switch the track selection knob to the required circuit (Circuit 1 shown below).

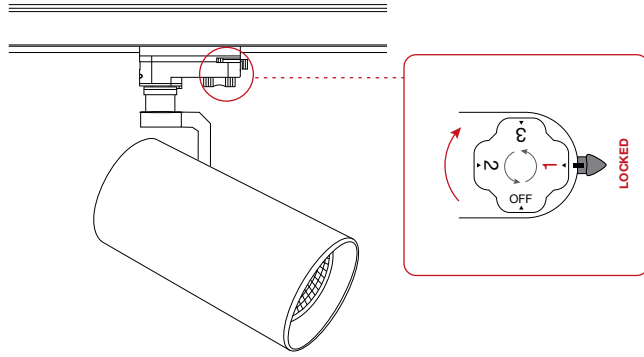

V1-02.05.2024 Product designs and technical data may be subject to change.

Track Spot XTB35

Installation Guide

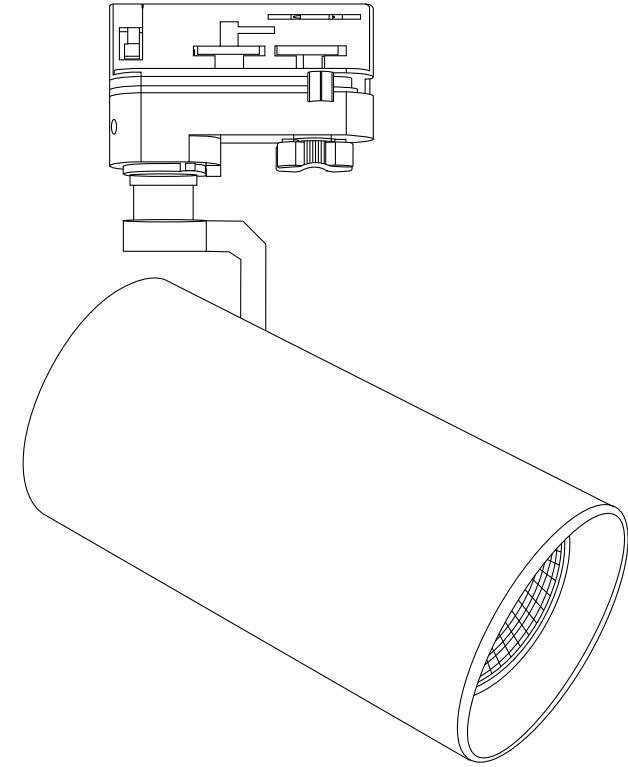

For warranty information, please visit
trendlighting.com.au/warranty

Important Safety Information

Please read these installation instructions carefully before installing this luminaire.

- This product must be installed by a licensed electrician in accordance with AS/NZS 3000 and local regulations.
- Isolate the mains power supply prior to installation.
- Only reconnect mains power after installation is completed.
- No part of the luminaire should be altered or modified.
- This product is not user serviceable.

Installation Notes



Product Code

XTB35

Dimensions

Ø115 mm x 216 (H) mm

1 Isolate the mains power supply prior to commencing installation.

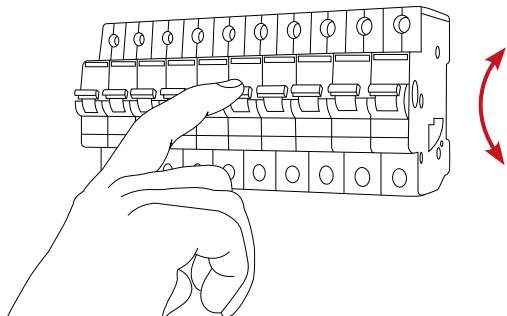

2 Check to ensure the circuit selector knob is set to 'off' and the locking lever is in the 'released' position.

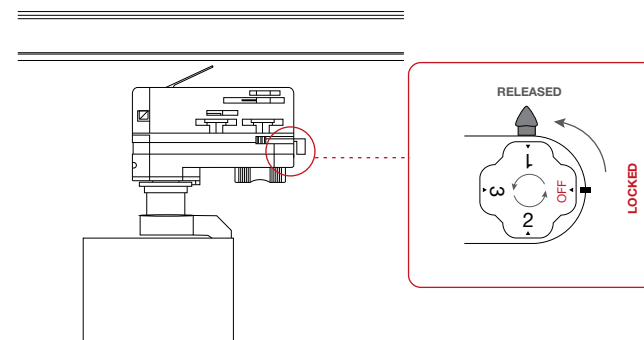

3 Ensure the track connector is oriented correctly in the track.

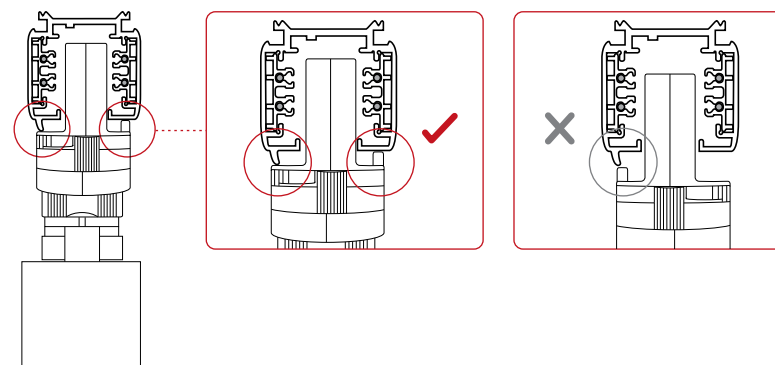

4 Insert luminaire into the track and move locking lever to the locked position.

